



## PREGLED SUDJELOVANJA

II. krug međunarodne lige za kadete GR



R.br.	EKIPA	MJESTO	42 kg	46 kg	50 kg	54 kg	58 kg	63 kg	69 kg	76 kg	85 kg	100 kg	Ukupno
1	BISTRA	BISTRA						1					1
2	GOSPIĆ	GOSPIĆ								1			1
3	HERKUL	ZAGREB	2						1	1			4
4	HRVATSKI DRAGOVOLJAC	ZAGREB			1		2				2		5
5	LIKA	ZAGREB					1		1	1			3
6	LUDBREG	LUDBREG						1	2	1			4
7	METALAC	ZAGREB					1	1	1	1	2		6
8	SESVETE	ZAGREB	1	1				2	1	1	1	1	8
9	SESVETSKI KRALJEVEC	SESV. KRALJEVEC	1			1						1	3
10	SISAK	SISAK				1			1		1		3
11	SLOVENIA	MURSKA SOBOTA									1		1
12	VINDIJA	VARAŽDIN			2			1	2	1		1	7
13	ZAGREB	ZAGREB	1			1			1		1	1	5
<b>UKUPNO NATJECATELJA</b>			<b>5</b>	<b>1</b>	<b>3</b>	<b>3</b>	<b>4</b>	<b>6</b>	<b>10</b>	<b>7</b>	<b>8</b>	<b>4</b>	<b>51</b>

R.br.	Hrvač	Ekipa	1	2	3	4	5	PP	PL.
1	BOŠNJAK Robert	ZAGREB		3	0	5	3	11	2.
2	PALATINUŠ Ivan	SESVETE	1		0	5	3	9	3.
3	OSMANOVIĆ Renato	SESVETSKI KRALJ	5	5		4	5	19	1.
4	PEPIĆ Marin	HERKUL	0	0	0		0	0	5.
5	REBIĆ Matej	HERKUL	1	1	0	4		6	4.

### N1

1	$\frac{3}{0}$	BOŠNJAK Robert	ZGB	$\frac{P1}{0}$ $\frac{P2}{0}$ $\frac{P3}{0}$
2	$\frac{1}{0}$	PALATINUŠ Ivan	SES	$\frac{P1}{0}$ $\frac{P2}{0}$ $\frac{P3}{0}$

3	$\frac{4}{0}$	OSMANOVIĆ Renato	SKR	$\frac{P1}{0}$ $\frac{P2}{0}$ $\frac{P3}{0}$
4	$\frac{0}{0}$	PEPIĆ Marin	HER	$\frac{P1}{0}$ $\frac{P2}{0}$ $\frac{P3}{0}$

### N2

5	$\frac{1}{0}$	REBIĆ Matej	HER	$\frac{P1}{0}$ $\frac{P2}{0}$ $\frac{P3}{0}$
1	$\frac{3}{0}$	BOŠNJAK Robert	ZGB	$\frac{P1}{0}$ $\frac{P2}{0}$ $\frac{P3}{0}$

2	$\frac{0}{0}$	PALATINUŠ Ivan	SES	$\frac{P1}{0}$ $\frac{P2}{0}$ $\frac{P3}{0}$
3	$\frac{5}{0}$	OSMANOVIĆ Renato	SKR	$\frac{P1}{0}$ $\frac{P2}{0}$ $\frac{P3}{0}$

### N3

4	$\frac{0}{0}$	PEPIĆ Marin	HER	$\frac{P1}{0}$ $\frac{P2}{0}$ $\frac{P3}{0}$
1	$\frac{5}{0}$	BOŠNJAK Robert	ZGB	$\frac{P1}{0}$ $\frac{P2}{0}$ $\frac{P3}{0}$

5	$\frac{1}{0}$	REBIĆ Matej	HER	$\frac{P1}{0}$ $\frac{P2}{0}$ $\frac{P3}{0}$
2	$\frac{3}{0}$	PALATINUŠ Ivan	SES	$\frac{P1}{0}$ $\frac{P2}{0}$ $\frac{P3}{0}$

### N4

3	$\frac{5}{0}$	OSMANOVIĆ Renato	SKR	$\frac{P1}{0}$ $\frac{P2}{0}$ $\frac{P3}{0}$
1	$\frac{0}{0}$	BOŠNJAK Robert	ZGB	$\frac{P1}{0}$ $\frac{P2}{0}$ $\frac{P3}{0}$

4	$\frac{0}{0}$	PEPIĆ Marin	HER	$\frac{P1}{0}$ $\frac{P2}{0}$ $\frac{P3}{0}$
5	$\frac{4}{0}$	REBIĆ Matej	HER	$\frac{P1}{0}$ $\frac{P2}{0}$ $\frac{P3}{0}$

### N5

2	$\frac{5}{0}$	PALATINUŠ Ivan	SES	$\frac{P1}{0}$ $\frac{P2}{0}$ $\frac{P3}{0}$
4	$\frac{0}{0}$	PEPIĆ Marin	HER	$\frac{P1}{0}$ $\frac{P2}{0}$ $\frac{P3}{0}$

3	$\frac{5}{0}$	OSMANOVIĆ Renato	SKR	$\frac{P1}{0}$ $\frac{P2}{0}$ $\frac{P3}{0}$
5	$\frac{0}{0}$	REBIĆ Matej	HER	$\frac{P1}{0}$ $\frac{P2}{0}$ $\frac{P3}{0}$

## KONAČNI POREDAK

Plasman	Hrvač	Ekipa
1	OSMANOVIĆ Renato	SKR
2	BOŠNJAK Robert	ZGB
3	PALATINUŠ Ivan	SES
4	REBIĆ Matej	HER
5	PEPIĆ Marin	HER



## TABLICA ELIMINACIJE



II. krug međunarodne lige za kadete GR

KAD GR 46 kg

R.br.	Hrvač	Ekipa	1	PP	PL.
1	ANTUNOVIĆ Luka	SESVETE		0	1.

## KONAČNI POREDAK

Plasman	Hrvač	Ekipa
1	ANTUNOVIĆ Luka	SES



## TABLICA ELIMINACIJE

II. krug međunarodne lige za kadete GR

KAD GR 50 kg



R.br.	Hrvač	Ekipa	1	2	3	PP	PL.
1	SLUNJSKI David	VINDIJA		0	0	0	3.
2	KNEŽEVIĆ Domagoj	HRVATSKI DRAGO	4		5	9	1.
3	FAJFARIĆ Luka	VINDIJA	4	0		4	2.

### N1

1	0 0	SLUNJSKI David	VIN	P1 0	P2 0	P3 0
2	4 0	KNEŽEVIĆ Domagoj	HD	P1 0	P2 0	P3 0

### N2

3	4 0	FAJFARIĆ Luka	VIN	P1 0	P2 0	P3 0
1	0 0	SLUNJSKI David	VIN	P1 0	P2 0	P3 0

### N3

2	5 0	KNEŽEVIĆ Domagoj	HD	P1 0	P2 0	P3 0
3	0 0	FAJFARIĆ Luka	VIN	P1 0	P2 0	P3 0

## KONAČNI POREDAK

Plasman	Hrvač	Ekipa
1	KNEŽEVIĆ Domagoj	HD
2	FAJFARIĆ Luka	VIND
3	SLUNJSKI David	VIND



## TABLICA ELIMINACIJE

II. krug međunarodne lige za kadete GR

KAD GR 54 kg



R.br.	Hrvač	Ekipa	1	2	3	PP	PL.
1	HADER Josip	ZAGREB		5	3	8	1.
2	ŠATOVIĆ Rafael	SISAK	0		0	0	3.
3	ŠIMUNKOVIĆ Nikola	SESVETSKI KRALJ	0	5		5	2.

N1						
1	5 0	HADER Josip	ZGB	P1 0	P2 0	P3 0
2	0 0	ŠATOVIĆ Rafael	SIS	P1 0	P2 0	P3 0

N2						
3	0 0	ŠIMUNKOVIĆ Nikola	SKR	P1 0	P2 0	P3 0
1	3 0	HADER Josip	ZGB	P1 0	P2 0	P3 0

N3						
2	0 0	ŠATOVIĆ Rafael	SIS	P1 0	P2 0	P3 0
3	5 0	ŠIMUNKOVIĆ Nikola	SKR	P1 0	P2 0	P3 0

## KONAČNI POREDAK

Plasman	Hrvač	Ekipa
1	HADER Josip	ZGB
2	ŠIMUNKOVIĆ Nikola	SKR
3	ŠATOVIĆ Rafael	SIS

R.br.	Hrvač	Ekipa	1	2	3	4	PP	PL.
1	ILIĆ Daniel	HRVATSKI DRAGO		0	0	0	0	4.
2	CELIČEK Domagoj	HRVATSKI DRAGO	4		0	0	4	3.
3	ZURAK Lovro	METALAC	5	5		1	11	2.
4	ČIBARIĆ Antonio	LIKA	4	4	4		12	1.

### N1

1	$\frac{0}{0}$	ILIĆ Daniel	HD	$\frac{P1}{0}$ $\frac{P2}{0}$ $\frac{P3}{0}$
2	$\frac{4}{0}$	CELIČEK Domagoj	HD	$\frac{P1}{0}$ $\frac{P2}{0}$ $\frac{P3}{0}$

3	$\frac{1}{0}$	ZURAK Lovro	MET	$\frac{P1}{0}$ $\frac{P2}{0}$ $\frac{P3}{0}$
4	$\frac{4}{0}$	ČIBARIĆ Antonio	LIK	$\frac{P1}{0}$ $\frac{P2}{0}$ $\frac{P3}{0}$

### N2

1	$\frac{0}{0}$	ILIĆ Daniel	HD	$\frac{P1}{0}$ $\frac{P2}{0}$ $\frac{P3}{0}$
3	$\frac{5}{0}$	ZURAK Lovro	MET	$\frac{P1}{0}$ $\frac{P2}{0}$ $\frac{P3}{0}$

2	$\frac{0}{0}$	CELIČEK Domagoj	HD	$\frac{P1}{0}$ $\frac{P2}{0}$ $\frac{P3}{0}$
4	$\frac{4}{0}$	ČIBARIĆ Antonio	LIK	$\frac{P1}{0}$ $\frac{P2}{0}$ $\frac{P3}{0}$

### N3

1	$\frac{0}{0}$	ILIĆ Daniel	HD	$\frac{P1}{0}$ $\frac{P2}{0}$ $\frac{P3}{0}$
4	$\frac{4}{0}$	ČIBARIĆ Antonio	LIK	$\frac{P1}{0}$ $\frac{P2}{0}$ $\frac{P3}{0}$

2	$\frac{0}{0}$	CELIČEK Domagoj	HD	$\frac{P1}{0}$ $\frac{P2}{0}$ $\frac{P3}{0}$
3	$\frac{5}{0}$	ZURAK Lovro	MET	$\frac{P1}{0}$ $\frac{P2}{0}$ $\frac{P3}{0}$

## KONAČNI POREDAK

Plasman	Hrvač	Ekipa
1	ČIBARIĆ Antonio	LIKA
2	ZURAK Lovro	MET
3	CELIČEK Domagoj	HD
4	ILIĆ Daniel	HD



# TABLICA ELIMINACIJE

II. krug međunarodne lige za kadete GR

KAD GR 63 kg



## Q

3	$\frac{0}{0}$	GRDANJSKI Fran	SES	P1	P2	P3
				0	0	
4	$\frac{5}{0}$	KELEMENIĆ Edi	VIN	P1	P2	P3
				0	0	
5	$\frac{4}{0}$	VINCELJ Dorijan	MET	P1	P2	P3
				0	0	
6	$\frac{0}{0}$	FERIN David	SES	P1	P2	P3
				0	0	

## 1/2 F

1	$\frac{4}{0}$	PRIHISTAL Luka	BIS	P1	P2	P3
				0	0	
2	$\frac{0}{0}$	ČURILA David	LUD	P1	P2	P3
				0	0	
4	$\frac{4}{0}$	KELEMENIĆ Edi	VIN	P1	P2	P3
				0	0	
5	$\frac{0}{0}$	VINCELJ Dorijan	MET	P1	P2	P3
				0	0	

## F 1-2

1	$\frac{5}{0}$	PRIHISTAL Luka	BIS	P1	P2	P3
				0	0	
1		PRIHISTAL Luka	BIS			
						1st place
4	$\frac{0}{0}$	KELEMENIĆ Edi	VIN	P1	P2	P3
				0	0	

## Repechage B

3	$\frac{1}{0}$	GRDANJSKI Fran	SES	P1	P2	P3
				0	0	
5		VINCELJ Dorijan	MET			
						3rd place
5	$\frac{4}{0}$	VINCELJ Dorijan	MET	P1	P2	P3
				0	0	

## KONAČNI POREDAK

Plasman	Hrvač	Ekipa
1	PRIHISTAL Luka	BIS
2	KELEMENIĆ Edi	VIND
3	ČURILA David	LUDB
3	VINCELJ Dorijan	MET
5	GRDANJSKI Fran	SES
6	FERIN David	SES



# TABLICA ELIMINACIJE

II. krug međunarodne lige za kadete GR

KAD GR 69 kg

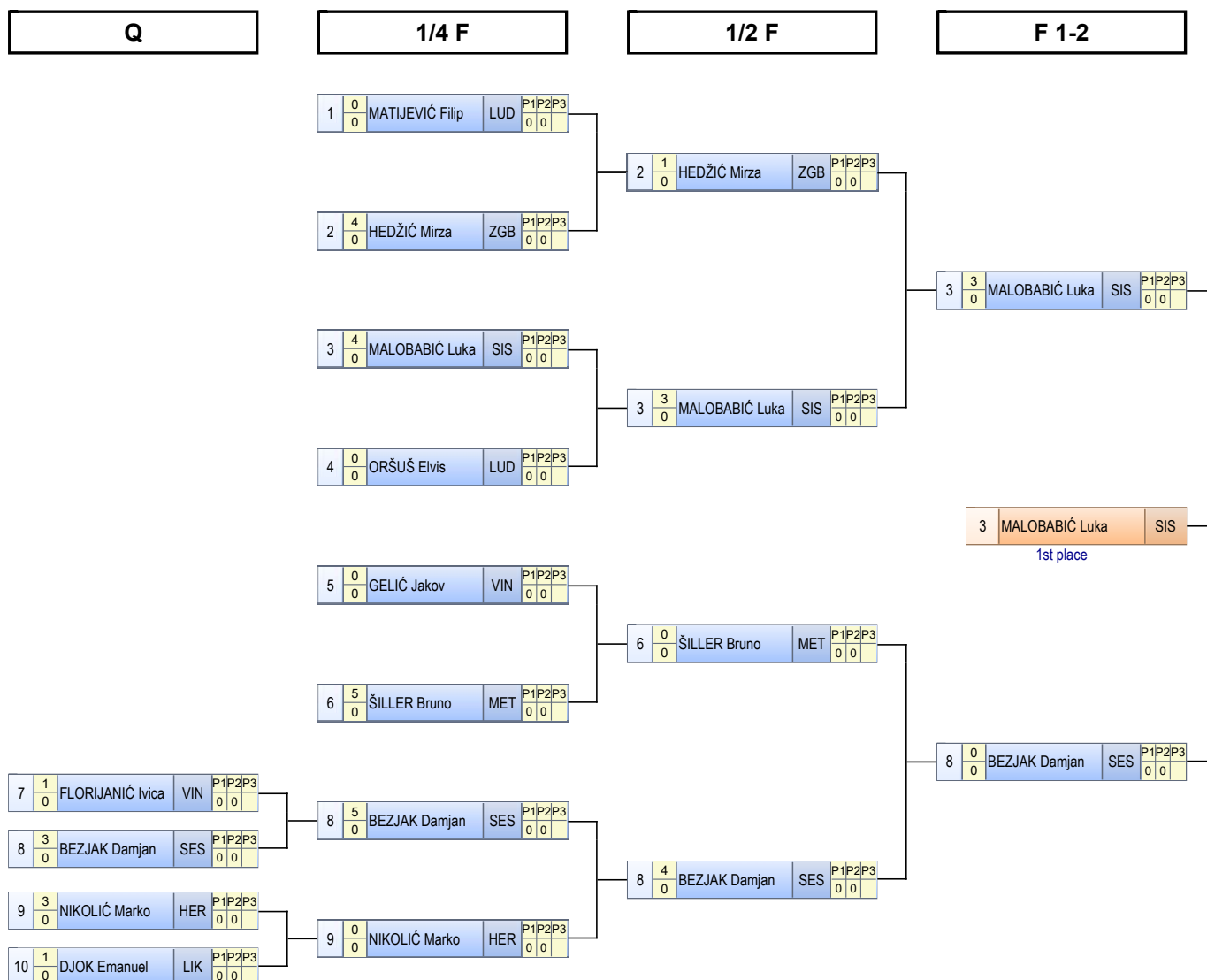

## KONAČNI POREDAK

### Repechage A

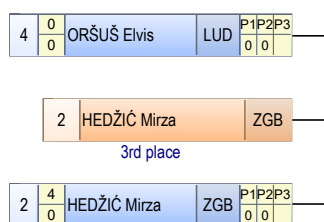

### Repechage B

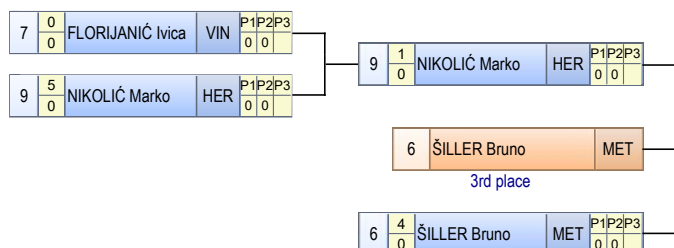

Plasman	Hrvač	Ekipa
1	MALOBABIĆ Luka	SIS
2	BEZJAK Damjan	SES
3	HEDŽIĆ Mirza	ZGB
3	ŠILLER Bruno	MET
5	ORŠUŠ Elvis	LUDB
5	NIKOLIĆ Marko	HER
7	FLORIJANIĆ Ivica	VIND
7	DJOK Emanuel	LIKA
9	MATIJEVIĆ Filip	LUDB
9	GELIĆ Jakov	VIND



# TABLICA ELIMINACIJE

II. krug međunarodne lige za kadete GR

KAD GR 76 kg



## Q

## 1/2 F

## F 1-2

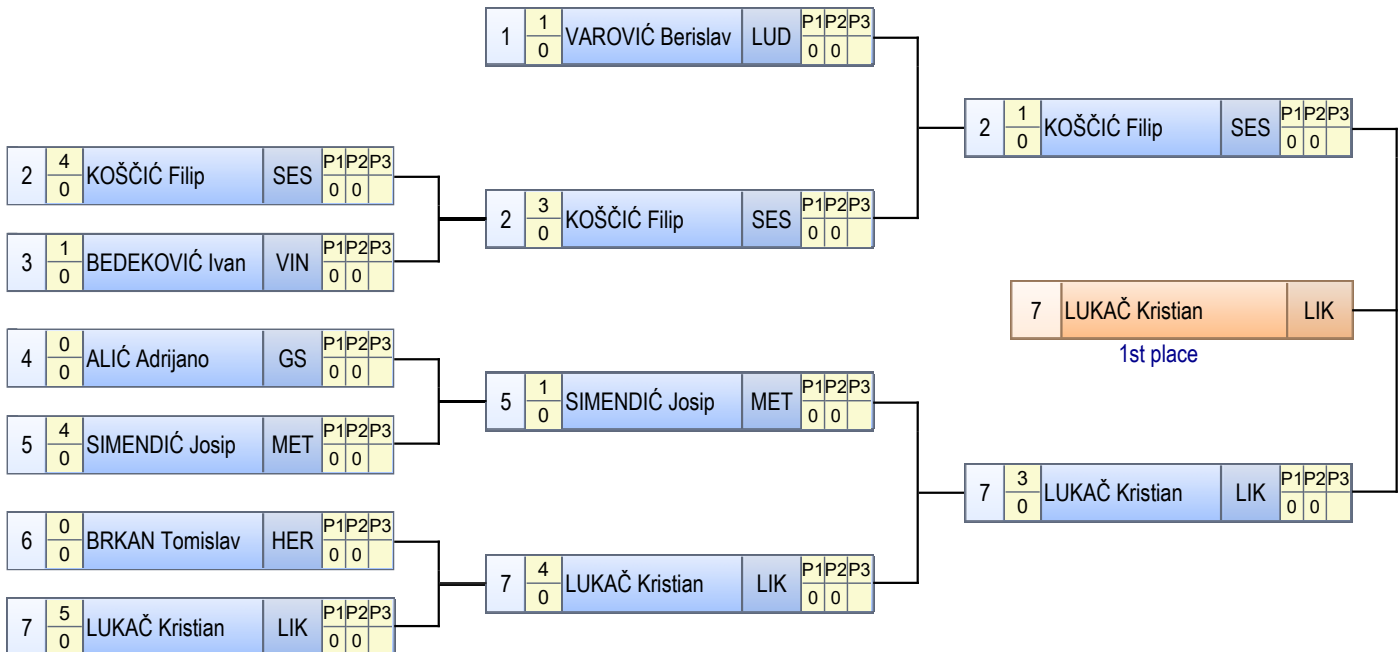

## KONAČNI POREDAK

Plasman	Hrvač	Ekipa
1	LUKAČ Kristian	LIKA
2	KOŠČIĆ Filip	SES
3	VAROVIĆ Berislav	LUDB
3	BRKAN Tomislav	HER
5	BEDEKOVIĆ Ivan	VIND
5	SIMENDIĆ Josip	MET
7	ALIĆ Adrijano	GS

## Repechage A

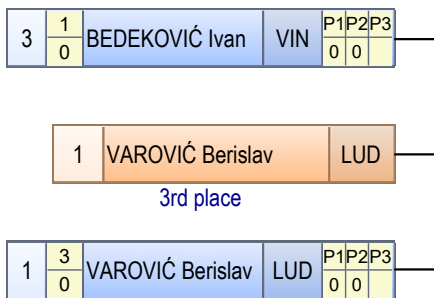

## Repechage B

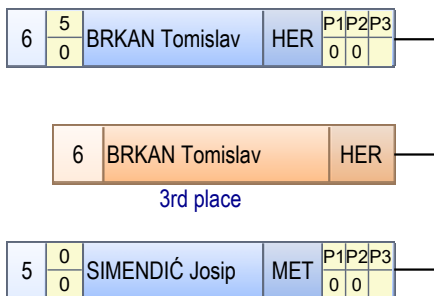



# TABLICA ELIMINACIJE

II. krug međunarodne lige za kadete GR

KAD GR 85 kg

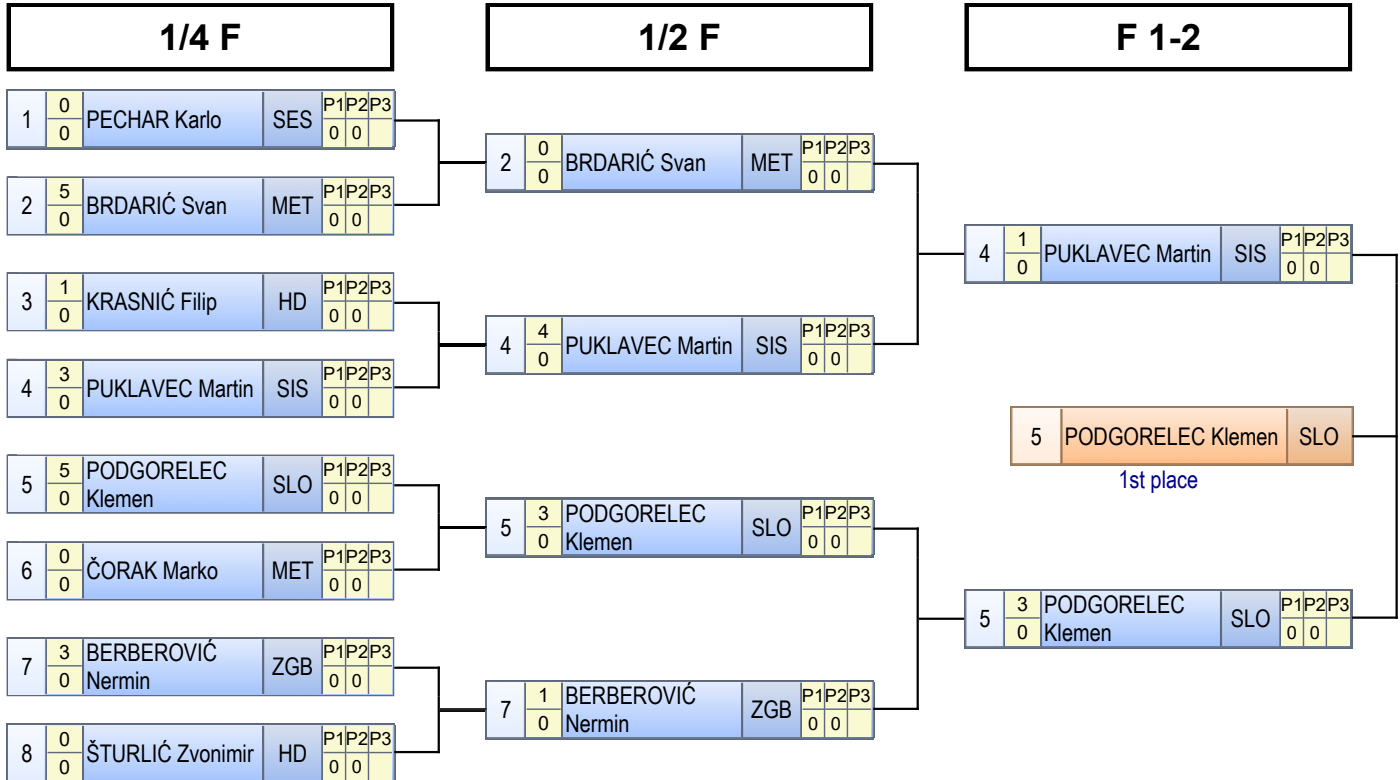

## KONAČNI POREDAK

Plasman	Hrvač	Ekipa
1	PODGORELEC Klemen	SLO
2	PUKLAVEC Martin	SIS
3	BRDARIĆ Svan	MET
3	BERBEROVIĆ Nermin	ZGB
5	KRASNIĆ Filip	HD
5	ČORAK Marko	MET
7	PECHAR Karlo	SES
7	ŠTURLIĆ Zvonimir	HD

### Repechage A

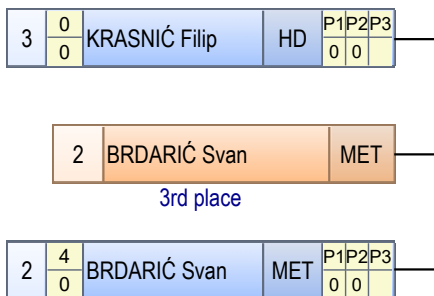

### Repechage B

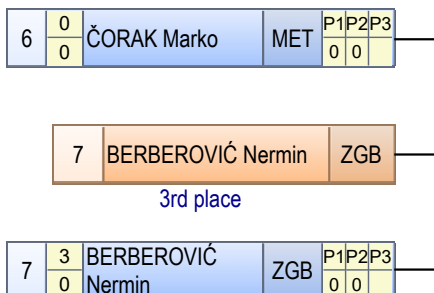



## TABLICA ELIMINACIJE



II. krug međunarodne lige za kadete GR

KAD GR 100 kg

R.br.	Hrvač	Ekipa	1	2	3	4	PP	PL.
1	IVANJKO David	SESVETE		4	3	4	11	1.
2	RUMPLIN Filip	VINDIJA	0		0	0	0	4.
3	DEBELJAK Marijan	SESVETSKI KRALJ	1	5		4	10	2.
4	BREZOVIĆ Ivan	ZAGREB	0	5	1		6	3.

### N1

1	$\frac{4}{0}$	IVANJKO David	SES	$\frac{P1}{0}$ $\frac{P2}{0}$ $\frac{P3}{0}$
2	$\frac{0}{0}$	RUMPLIN Filip	VIN	$\frac{P1}{0}$ $\frac{P2}{0}$ $\frac{P3}{0}$

3	$\frac{4}{0}$	DEBELJAK Marijan	SKR	$\frac{P1}{0}$ $\frac{P2}{0}$ $\frac{P3}{0}$
4	$\frac{1}{0}$	BREZOVIĆ Ivan	ZGB	$\frac{P1}{0}$ $\frac{P2}{0}$ $\frac{P3}{0}$

### N2

1	$\frac{3}{0}$	IVANJKO David	SES	$\frac{P1}{0}$ $\frac{P2}{0}$ $\frac{P3}{0}$
3	$\frac{1}{0}$	DEBELJAK Marijan	SKR	$\frac{P1}{0}$ $\frac{P2}{0}$ $\frac{P3}{0}$

2	$\frac{0}{0}$	RUMPLIN Filip	VIN	$\frac{P1}{0}$ $\frac{P2}{0}$ $\frac{P3}{0}$
4	$\frac{5}{0}$	BREZOVIĆ Ivan	ZGB	$\frac{P1}{0}$ $\frac{P2}{0}$ $\frac{P3}{0}$

### N3

1	$\frac{4}{0}$	IVANJKO David	SES	$\frac{P1}{0}$ $\frac{P2}{0}$ $\frac{P3}{0}$
4	$\frac{0}{0}$	BREZOVIĆ Ivan	ZGB	$\frac{P1}{0}$ $\frac{P2}{0}$ $\frac{P3}{0}$

2	$\frac{0}{0}$	RUMPLIN Filip	VIN	$\frac{P1}{0}$ $\frac{P2}{0}$ $\frac{P3}{0}$
3	$\frac{5}{0}$	DEBELJAK Marijan	SKR	$\frac{P1}{0}$ $\frac{P2}{0}$ $\frac{P3}{0}$

## KONAČNI POREDAK

Plasman	Hrvač	Ekipa
1	IVANJKO David	SES
2	DEBELJAK Marijan	SKR
3	BREZOVIĆ Ivan	ZGB
4	RUMPLIN Filip	VIND



# POJEDINAČNI POREDAK PO KATEGORIJAMA



II. krug međunarodne lige za kadete GR

KAD GR

<b>42 kg</b>			
1	OSMANOVIĆ Renato	SESVETSKI KRALJEVEC	7.0
2	BOŠNJAK Robert	ZAGREB	5.0
3	PALATINUŠ Ivan	SESVETE	3.5
4	REBIĆ Matej	HERKUL	3.5
5	PEPIĆ Marin	HERKUL	
			<b>19.0</b>
<b>46 kg</b>			
1	ANTUNOVIĆ Luka	SESVETE	7.0
			<b>7.0</b>
<b>50 kg</b>			
1	KNEŽEVIĆ Domagoj	HRVATSKI DRAGOVOLJAC	7.0
2	FAJFARIĆ Luka	VINDIJA	5.0
3	SLUNJSKI David	VINDIJA	
			<b>12.0</b>
<b>54 kg</b>			
1	HADER Josip	ZAGREB	7.0
2	ŠIMUNKOVIĆ Nikola	SESVETSKI KRALJEVEC	5.0
3	ŠATOVIĆ Rafael	SISAK	3.5
			<b>15.5</b>
<b>58 kg</b>			
1	ČIBARIĆ Antonio	LIKA	7.0
2	ZURAK Lovro	METALAC	5.0
3	CELIČEK Domagoj	HRVATSKI DRAGOVOLJAC	3.5
4	ILIĆ Daniel	HRVATSKI DRAGOVOLJAC	
			<b>15.5</b>
<b>63 kg</b>			
1	PRIHISTAL Luka	BISTRA	7.0
2	KELEMENIĆ Edi	VINDIJA	5.0
3	ČURILA David	LUDBREG	3.5
3	VINCELJ Dorijan	METALAC	3.5
5	GRDANJSKI Fran	SESVETE	1.5
6	FERIN David	SESVETE	
			<b>20.5</b>
<b>69 kg</b>			
1	MALOBABIĆ Luka	SISAK	7.0
2	BEZJAK Damjan	SESVETE	5.0
3	HEDŽIĆ Mirza	ZAGREB	3.5
3	ŠILLER Bruno	METALAC	3.5
5	ORŠUŠ Elvis	LUDBREG	1.5
5	NIKOLIĆ Marko	HERKUL	1.5
			<b>22.0</b>
<b>76 kg</b>			
1	LUKAČ Kristian	LIKA	7.0
2	KOŠČIĆ Filip	SESVETE	5.0
3	VAROVIĆ Berislav	LUDBREG	3.5
3	BRKAN Tomislav	HERKUL	3.5
5	BEDEKOVIĆ Ivan	VINDIJA	1.5
5	SIMENDIĆ Josip	METALAC	1.5
			<b>22.0</b>
<b>85 kg</b>			
1	PODGORELEC Klemen	SLOVENIA	7.0
2	PUKLAVEC Martin	SISAK	5.0



## POJEDINAČNI POREDAK PO KATEGORIJAMA



II. krug međunarodne lige za kadete GR

KAD GR

3	BRDARIĆ Svan	METALAC	3.5
3	BERBEROVIĆ Nermin	ZAGREB	3.5
5	KRASNIĆ Filip	HRVATSKI DRAGOVOLJAC	1.5
5	ČORAK Marko	METALAC	
			<b>20.5</b>

<b>100 kg</b>			
1	IVANJKO David	SESVETE	7.0
2	DEBELJAK Marijan	SESVETSKI KRALJEVEC	5.0
3	BREZOVIĆ Ivan	ZAGREB	3.5
4	RUMPLIN Filip	VINDIJA	3.5
			<b>19.0</b>



## EKIPNI PLASMAN

II. krug međunarodne lige za kadete GR



R.br.	EKIPA	MJESTO	42 kg	46 kg	50 kg	54 kg	58 kg	63 kg	69 kg	76 kg	85 kg	100 kg	Ukupno
1	SESVETE	ZAGREB	3.5	7.0				1.5	5.0	5.0		7.0	29.0
2	ZAGREB	ZAGREB	5.0			7.0			3.5		3.5	3.5	22.5
3	SESVETSKI KRALJEVEC	SESV. KRALJEVEC	7.0			5.0						5.0	17.0
4	METALAC	ZAGREB					5.0	3.5	3.5	1.5	3.5		17.0
5	SISAK	SISAK				3.5			7.0		5.0		15.5
6	VINDIJA	VARAŽDIN			5.0			5.0		1.5		3.5	15.0
7	LIKA	ZAGREB					7.0			7.0			14.0
8	HRVATSKI DRAGOVOLJAC	ZAGREB			7.0		3.5				1.5		12.0
9	HERKUL	ZAGREB	3.5						1.5	3.5			8.5
10	LUDBREG	LUDBREG						3.5	1.5	3.5			8.5
11	BISTRA	BISTRA						7.0					7.0
11	SLOVENIA	MURSKA SOBOTA									7.0		7.0
13	GOSPIĆ	GOSPIĆ											0.0
<b>UKUPNO</b>			<b>19</b>	<b>7</b>	<b>12</b>	<b>15.5</b>	<b>15.5</b>	<b>20.5</b>	<b>22</b>	<b>22</b>	<b>20.5</b>	<b>19</b>	<b>173</b>